

# **STEELSHIELD FR 60**

# **EXTERNAL FIRE**

# **RESISTING DOOR**

Data Sheet

# Steel Shield FR60- External Door

Secure perimeter door, ensuring optimum protection from air, wind and water. Provides a secure function for personnel access or means of escape.

## Design

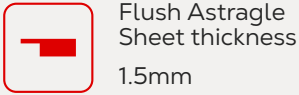
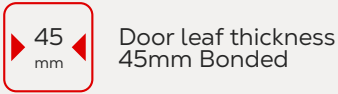

## Main function

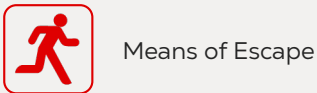
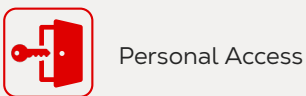

## Additional performance characteristics Under 14351-1

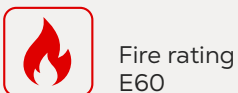
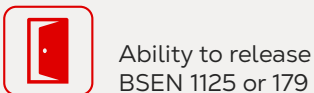
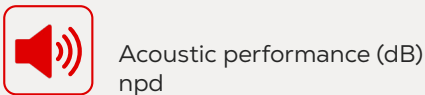
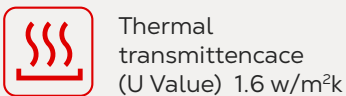
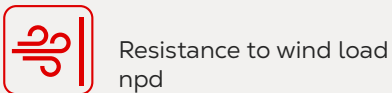
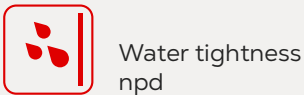
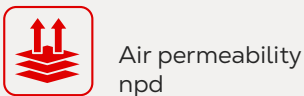

## Dimensions (mm)

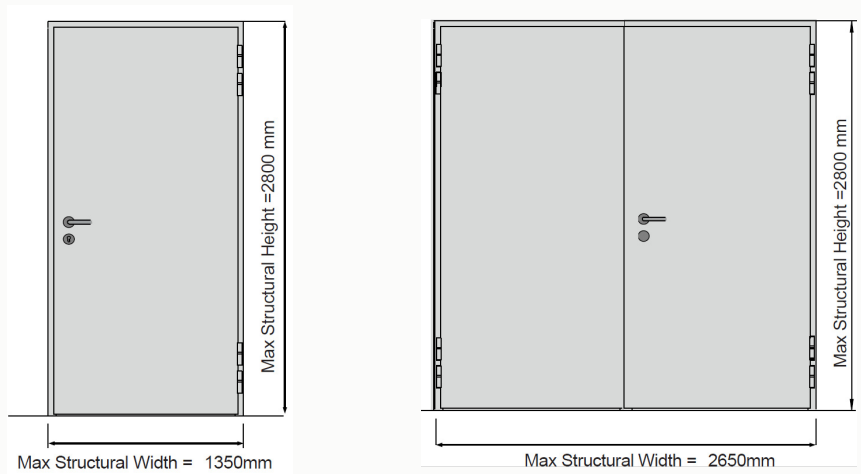

## Product description

Description	Steel Shield FR60
Type	Steel perimeter security door Fire Rated
Use	Security door with CE marking for fitting in external walls for use as a Personnel Access or Means of Escape door
CE Marked to	EN 14351-1 and 16034
Leaf thickness	45mm
Steel thickness leaf	1.5mm
Astragale	Joggled strike side
Steel thickness frame	1.5mm
Design	Twin skinned bonded/ mechanical fixed/welded around core
Surface finish	Door leaf and frame galvanised steel
Security bolts	8mm dia built into each hinge
Core	Insulated mineral fibre board to achieve an estimated U value of 1.6 w/m²k
Over & Side Panels	Not Available

## Finish

In house applied and highly durable external polyester powdercoat to RAL or BS4800 colour reference. 7 year warranty\* on finish for adhesion and colour stability.



\*C3 non marine environment

## Standard Hardware Fittings

Level handle set	Briton 5700 series DIN standard mortice lock range offering, sashlock, deadlock, nightlatch, latch, toilet lock and escape sashlock. Stainless steel 19mm dia round bar bolt through lever
Hinges and closing devices	4 No stainless steel Class 14 to BSEN 1935 c/w 8mm security bolt. ASSA 200/300 Surface mgt Door Closer or Geze 2000/4000 Surface mgt Door Closers
Profile cylinders	Supplied in optional configuration, choose from cylinder & turn, double cylinder, single cylinder. Standard differ supplied for multiple doors. Master key available upon request.
Means of escape devices	BS EN 1125 compliant 300 series from Briton or Exidor 500 series or Strand PH Pullman latch series .

## Vision Panel Options



Two Part Screw together vision panel, glazed with 9mm Firelite 60 minute fire glass

### Standard Options



200x1100

## Louvre Panel Options

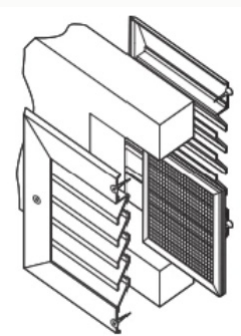

Two Part Screw together non vision louvre panel sandwiching an internal intumescent air transfer block

### Standard Options



305x305  
Lower



457x457  
Lower



610x610  
Lower

### Custom

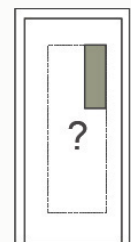

Max size  
657x657

## Standard frame steel shield

Standard single rebate frame

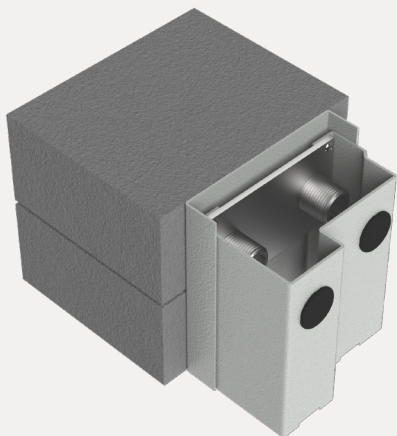

Fitting method Diagonal fixing:

The door frame is fixed to the wall using prefabricated holes with plugs and bolts.

Frame sheet thickness 1.5mm

Surface finish

Galvanised steel.

Frame seal

All-round on 3 sides or 4 sides, black.

Fitting possible in:

Brickwork/concrete  
Gas concrete  
Prefabricated wall  
Composite Panel,  
Steel Work

## Door Frame Options

Steel shield external doors come with a choice of frames to suit the widest possible structural doorway constructions. As standard they come with the rapid fit "jacking screw" arrangement and adjustable sub frame channels that allow our doors to have the correct tolerance. This ensures simple installation, whilst expanding to fill the structural opening and leave a neat joint ready for mastic to be applied.

Standard Single Rebate

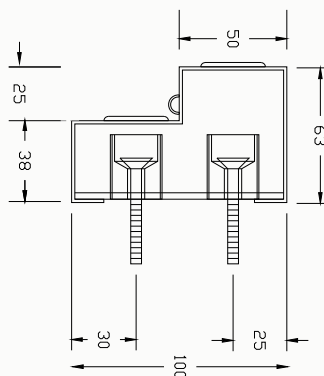

## Threshold Options

G: 12.7mm High Raised Outward Opening

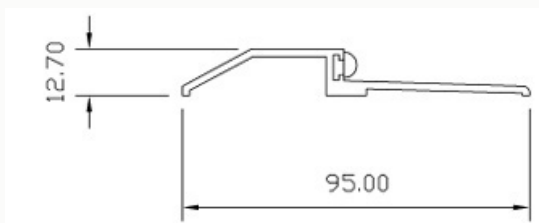

H: 15mm High Pressed Metal

